



**gofanco®**

## 4-Port HDMI Extender/Splitter over CAT5e/6 with IR - 40M



P/N: HDMIExt4P

G4-0022A





***Congratulations for owning a gofanco product. Our products aim to meet all your connectivity needs wherever you go. Have fun with our products!***

***Please read this manual carefully before first use.***

If you need more information about our products, please visit [www.gofanco.com](http://www.gofanco.com).

For technical support, please email us at [support@gofanco.com](mailto:support@gofanco.com).

For drivers/manuals download, please go to <http://www.gofanco.com/download>.





## Introduction

gofanco 4-Port HDMI Extender/Splitter over CAT5e/6 with IR - 40M (part# HDMIExt4P) extends HDMI signals to four monitors over Cat5e/6 up to 40m with 1080p.

## Specifications

Output Signal	HDMI
Protocol	HDbitT
Resolution	Up to 1080p
Transmission Distance	Up to 40m (130ft)
Network Cable	CAT5e/6 (CAT6 recommended)
HDMI Cable	Up to 5m (Input & Output)
Power Supply	TX: DC 5V /3A, RX: DC 5V /1A
IR Signal	20~60KHz IR devices supported



## Package Contents

- 4-Port HDMI Extender/Splitter over CAT5e/6 with IR - 40M (1x TX & 4x RXs)
- 5x Power adapters
- IR Blaster extension cable & IR Receiver extension cables
- Screw kit
- User's guide



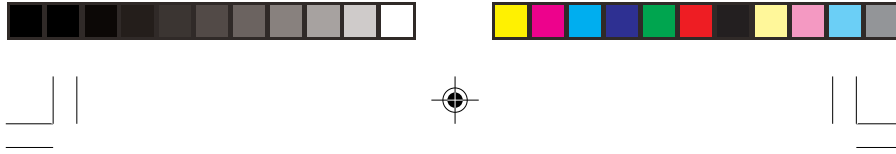

## Layout

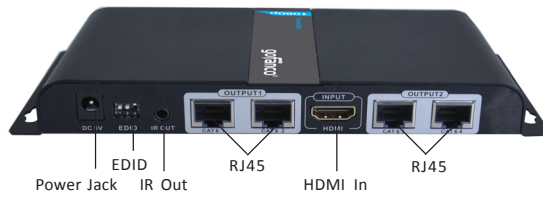
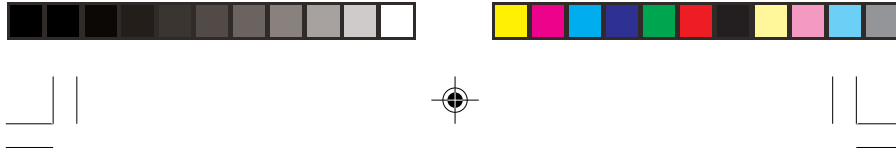

Figure 1: Transmitter (TX)

- **Power Jack:** Connect the included 5V/3A DC power adapter here
- **EDID :** The HDMI source device reads EDID information from the TX unit, and outputs it to the RXs. Please refer to the settings below.

EDID Setting		HDMI signal format
Position		
 1      2		1: 720p @50Hz (2-Ch) 2: 720p @50Hz (2-Ch)
 3		3: 720p @50Hz (7.1-Ch)
 4      5		4: 1080i @60Hz (2-Ch) 5: 1080i @60Hz (7.1-Ch)
 6      7		6: 1080p @60Hz (2-Ch) * 7: 1080p @60Hz (7.1-Ch)

\* 6: Default setting



- **IR Out:** Infrared 3.5mm socket. Plug [IR Blaster](#) extension cable here. See instructions on page 7.
- **RJ45 (1):** Link to Receiver 1's RJ45 via a Cat5e/6 cable
- **RJ45 (2):** Link to Receiver 2's RJ45 via a Cat5e/6 cable
- **HDMI In:** Connect your HDMI source here with an HDMI cable (cable not included)
- **RJ45 (3):** Link to Receiver 3's RJ45 via a Cat5e/6 cable
- **RJ45 (4):** Link to Receiver 4's RJ45 via a Cat5e/6 cable



Figure 2: Transmitter (TX)

- **Link LED:** Turns red when powered. Turns blue when there is an HDMI signal detected
- **Reset:** Press to reset if HDMI Extender doesn't work properly

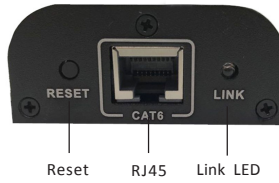
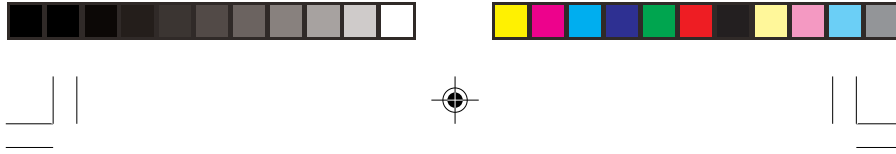

**Figure 3: Receiver (RX) - RJ45 Input**

- **Reset:** Press to reset if HDMI Extender doesn't work properly
- **RJ45:** Link to the Transmitter's RJ45 via a Cat5e/6 cable
- **Link LED:** Blinks when powered on. ON when the Cat5e/6 cable is connected/linked properly between the Transmitter and Receiver

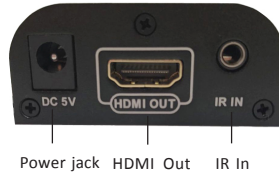

**Figure 4: Receiver (RX) - HDMI Display Output**

- **Power Jack:** Connect the included 5V/1A DC power adapter here
- **HDMI Out:** Connect your HDMI display here with an HDMI cable (cable not included)
- **IR In:** Infrared 3.5mm socket. Plug IR Receiver extension cable here. See instructions on page 7.

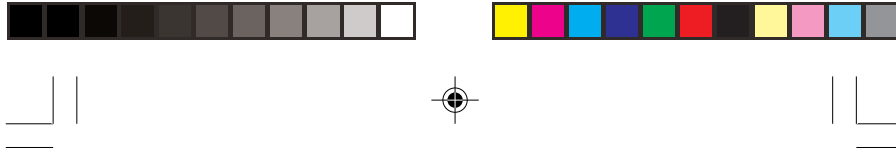

### IR Extenders



**Figure 5: IR Blaster**  
(Connect to Transmitter TX)



**Figure 6: IR Receiver**  
(Connect to Receiver RX)

- **IR Blaster:** Plug into the Transmitter's IR 3.5 socket to emit IR signals.
- **IR Receiver:** Plug into the Receiver's IR 3.5 socket to receive IR signals from a remote control (for the HDMI device connected to the Transmitter).

**Note:** Incorrect placement of the IR Blaster and IR Receiver may result in failure of these cables. Please check carefully before plugging in the IR cables to proper IR sockets.

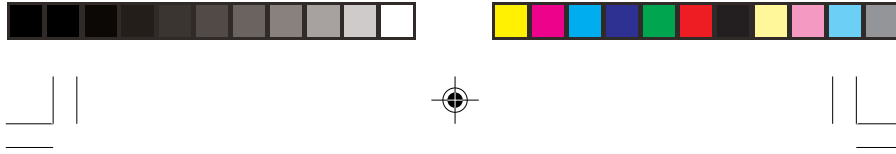

## Hardware Installation

**Note:** To achieve optimal performance, CAT6 cable is recommended.

1. Power off all devices including your HDMI source and display.
2. Connect your HDMI source to the Transmitter's **HDMI IN** connector.
3. Optional: Connect the IR Blaster extension cable to the Transmitter's **IR Out**. Face the eye towards your HDMI device's IR window.
4. Connect your HDMI display to the Receiver's **HDMI OUT** connector with an HDMI cable (not included). Repeat this step for all Receivers.
5. Optional: Connect the IR Receiver extension cable to the Receiver's **IR In**. Repeat this step for all Receivers.
6. Switch the **EDID** according to your desired HDMI signal format. Refer to page 4 for details.
7. Connect and link the Transmitter and Receivers by CAT5e/6 cables.
8. Plug the included power adapters into the Transmitter's and Receivers' **Power Jacks**, then plug all power adapters into reliable power outlets.
9. Power on your HDMI device and HDMI displays.
10. The HDMI Extender is ready for use.





## Application

Easily extends HDMI signals such as DVD players or computers to four remote displays simultaneously. An ideal solution for exhibitions, video conferences, show centers, and etc..

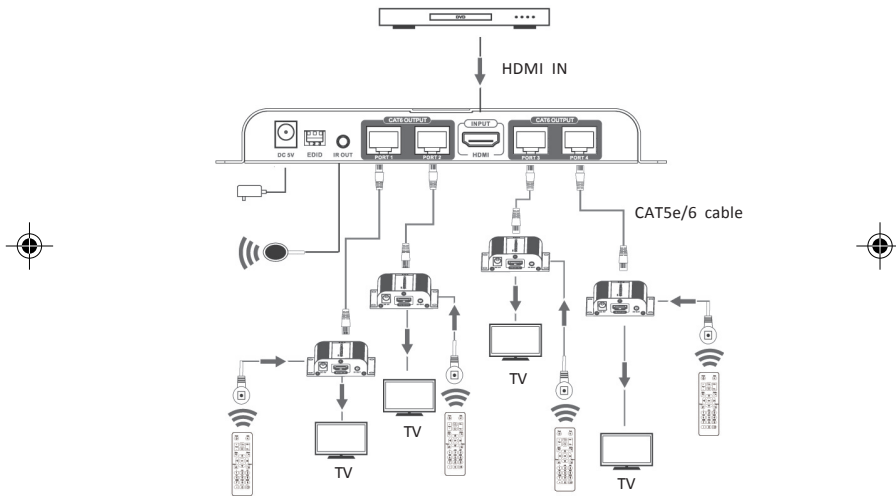
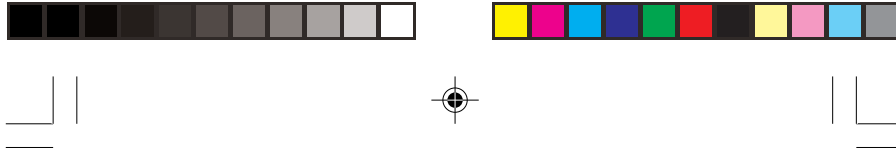

Figure 7

\* When using the remote control, please make sure its distance to the IR Receiver extension cable is within 5 meters (16.4 ft) and without obstructions.





## FAQ & Solutions

---

**Q:** There is no picture on the TVs:

- A:** 1) Check whether the correct TV input is selected.  
2) Check whether the "Link" LED on TX and RXs are on.  
If the RX's Link LED blinks, it means the RX doesn't receive signals from the TX.  
3) Make sure the resolution of the input HDMI source is supported by this Extender/Splitter.

**Q:** There is unstable picture on the TVs:

- A:** 1) Switch the "EDID" to the appropriate position, refer to page 4 for details.  
2) Unplug the Cat5e/6 cable and plug in again.  
If the issue still exists, use other Cat5e/6 cables.

**Q:** Only one TV has image:

- A:** 1) Make sure the CAT cables and HDMI cable are connected correctly and securely.  
2) Press the "Reset" button on the TX to re-identify the HDMI signal.  
3) Unplug the Cat5e/6 cable and plug in again.



**Blank Page**





**gofanco**<sup>®</sup>



*Thank you for choosing gofanco*



[www.gofanco.com](http://www.gofanco.com)

